

NOVIGAMI

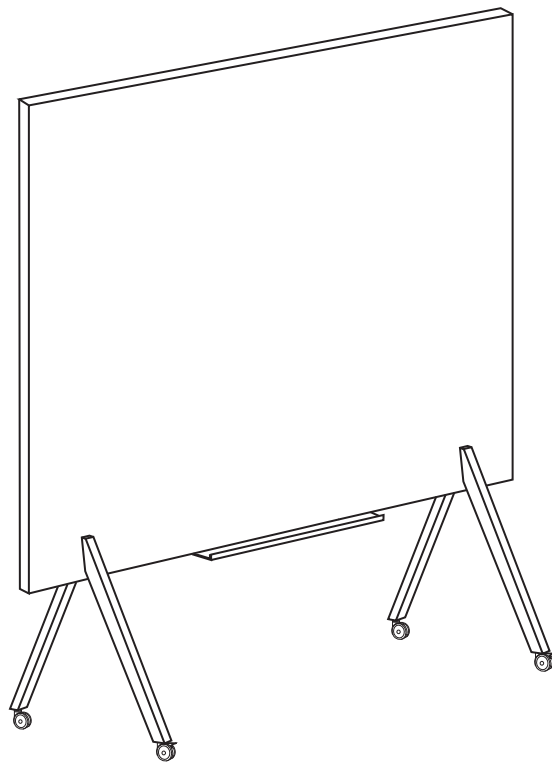







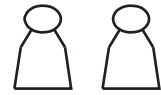

NOVIGAMI RAMI Wooden Leg Pack **NV-WBLEG**

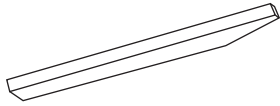
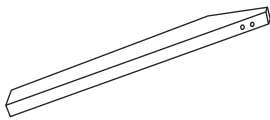
Assembly & User Instructions

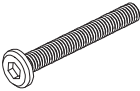
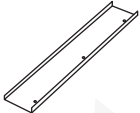
Montage - und Bedienungsanleitung
Notice de montage

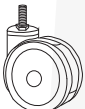

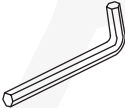
2 PERSON
ASSEMBLY

Letter Buchstabe Lettre	Components Teile Composants	Pieces Stückzahl Quantité
A	 Wooden Legs Holzbein Pieds en bois	× 2
B	 Wooden Legs Holzbeine Pieds en bois	× 2
C	 12 mm Screw 12 mm Schraube Vis 12 mm	× 3
D	 70 mm Screw 70 mm Schraube Vis 70 mm	× 4
E	 Pen Tray Stiftablage Porte-Stylo	× 1
F	 Locking Castors Feststellbare Rollen Roulettes avec frein	× 2
G	 Standard Castors Standard-Rollen Roulettes Standard	× 2
H	 Spanner Schraubenschlüssel Clé Plate	× 1
I	 Allen Key Inbusschlüssel Clé Allen	× 1
J	 Cam Covers Schraubenabdeckung Cache	× 4
K	 Washers Unterlegscheiben Rondelles	× 4

Additional tools required: 1 x cross-head screwdriver
 Zusätzlich benötigtes Werkzeug: Kreuzschlitzschraubendreher
 Outils supplémentaires requis: tournevis cruciforme

IMPORTANT: Do not tighten bolts fully until you have completed assembly.

WICHTIG: Schrauben erst nach vollständiger Montage komplett anziehen.

IMPORTANT: Ne serrez pas complètement les vis avant d'avoir terminé le montage.

1 ENGLISH: Screw the locking castors (F) and standard castors (G) into wooden legs A and B with the spanner (H) provided.

DEUTSCH: Schraube die feststellbaren Rollen (F) und die Standardrollen (G) mit dem mitgelieferten Schraubenschlüssel (H) in die Holzbeine A und B.

FRANÇAIS: Vissez les roulettes avec frein (F) et les roulettes standard (G) dans les pieds en bois A et B avec la clé plate (H).

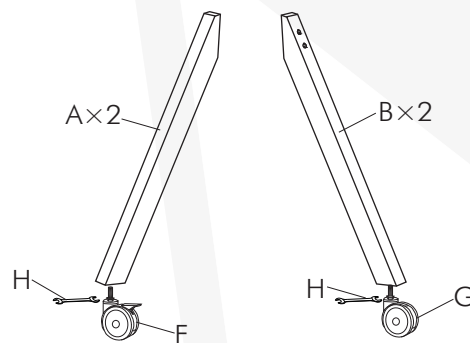

2 ENGLISH: Insert the pen tray (E) into the board using 3 x screws (C).

DEUTSCH: Befestige die Stiftablage (E) mit 3 x Schrauben (C) am Board.

FRANÇAIS: Insérez le porte-stylo (E) dans le tableau à l'aide de 3 x vis (C).

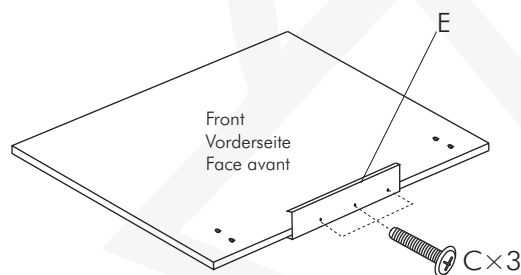

3 ENGLISH: Attach the wooden legs to the rear of the board using 4 x screws (D), 4 x washers (K) and the allen key (I) provided.

Please fit cam covers (J) onto visible/exposed screws (D) to complete the assembly.

DEUTSCH: Befestige die Holzbeine mit 4 Schrauben (D) und 4 Unterlegscheiben (K) mithilfe des mitgelieferten Inbusschlüssels (I) an der Rückseite des Boards.

Montiere bitte die Schraubenabdeckungen (J) auf die sichtbaren/freiliegenden Schrauben (D), um die Montage abzuschließen.

FRANÇAIS: Fixez les pieds en bois à l'arrière du tableau à l'aide de 4 vis (D) et 4 rondelles (K) à l'arrière de la planche en utilisant la clé Allen fournie (I).

Placez les caches (J) sur les vis visibles (D) pour finir le montage.

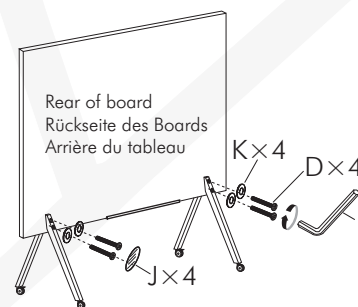

If you have any questions or need help, please contact your local supplier or visit www.novigami.com

Falls du Fragen hast oder Hilfe benötigst, wende dich bitte an deine Verkaufsstelle oder besuche www.novigami.com

Si vous des questions ou si vous avez besoin d'aide, veuillez contacter votre fournisseur local ou consulter le site www.novigami.com